



GIB[®]

Wet Area Systems

Specification and installation manual

CBI 5113

FEBRUARY 2021

WCC Approved plans SR496352 : 03/08/2021 A copy must be kept on site

NATIONAL SUPPORT

VISIT: Winstone Wallboards Limited
37 Felix Street, Penrose,
Auckland 1061, New Zealand

POST: PO Box 12 256, Penrose,
Auckland 1642, New Zealand

PHONE: +64 9 633 0100

EMAIL: info@gib.co.nz

WEB: gib.co.nz

GIB® HELPLINE

0800 100 442

RESIDENTIAL AND NON-RESIDENTIAL APPLICATIONS. BATHROOMS, LAUNDRIES, TOILETS AND KITCHENS.

Protection from internal moisture is an important consideration when designing interior lining systems for homes, multi-unit apartments, educational, healthcare and commercial applications.

The New Zealand Building Code sets out minimum standards for wet area spaces in residential dwellings. However, often higher levels of performance and protection from internal moisture is demanded.

The GIB® Wet Areas System specification and installation manual provides internal lining options and details for specifiers, builders and building owners.

USE ONLY THE CURRENT SPECIFICATION

This manual supersedes the publication GIB Aqualine® Wet Area Systems March 2007. Winstone Wallboards Ltd accepts no liability for reliance upon publications that have been superseded.

If you are unsure whether this is the current publication, call the GIB® Helpline on 0800 100 442 or go to gib.co.nz

BEWARE OF SUBSTITUTION

The performance of GIB® Wet Area Systems requires accurate design detailing and construction practices. All GIB® Systems have been developed specifically for New Zealand conditions and independently tested, assessed or appraised, to ensure the required level of performance. It is important to use GIB® components where specified and to closely follow the specified design details and construction practices, to be confident that the required level of performance and quality is achieved on site.

CONTENTS

Introduction	5	Construction Details	18-30
Design considerations	6-11	Limitations	31
Where to use GIB® Wet Area linings	6	Use only the current specification	31
Benefits	6	Substitution	31
Handling and storage	6	Trademarks	31
Limitations	6	Copyright	31
Board substitution options	7		
Penetrations and sealants	8		
Renovations	8		
Maintenance	8		
Compliance with the NZ Building Code	9-11		
Installation	12-17		
Non-tiled walls – Timber Framing	12		
Non-tiled walls – Steel Framing	13		
Tiled walls – Timber Framing	14		
Tiled walls – Steel Framing	15		
Metal angles and maximum tile weights	16		
Ceilings	17		

This publication

This publication is a best practice guide to the design and construction of wall and ceiling linings in wet areas with intermittent water exposure within residential and non-residential buildings, as covered by NZ Building Code Clause E3 Internal Moisture.

The information is designed to be helpful to designers, contractors and home-owners wishing to achieve a result that is easy to incorporate into modern design, simple and clear to construct, and that will satisfy the needs, requirements and expectations of both the NZ Building Code and the end user.

Wet areas in the home often require relatively frequent and expensive renovation or repair, often because of the ingress of water to the structure of the building.

To form a complete wet area system it is important to specify compatible materials and systems, designed to cope with conditions that are common in wet areas, and to ensure correct installation using best practice.

WET AREAS

Generally, wet areas are described as spaces to where fresh water is reticulated, such as bathrooms, toilets, laundries and kitchens. Within wet areas the following requirements apply;

1. NZBC Clause E3.3.4 states that wall surfaces adjacent to sanitary fixtures or sanitary appliances must be impervious and easily cleaned.
2. NZBC Clause E3.3.6 states that surfaces of building elements likely to be splashed must be constructed in a way that prevents water splash from penetrating behind linings or into concealed spaces.

NZ Building Code Clause E3 also refers to other requirements not covered in this publication, such as ventilation, condensation control and overflow management. Ongoing maintenance of wet areas is also important to maximise service life.

GIB AQUALINE®, GIB TOUGHLINE® AQUA AND GIB WEATHERLINE®

Although able to cope with infrequent short-term exposure, standard gypsum plasterboard will have a shortened life expectancy when frequently exposed to water or a high moisture environment.

The NZ Building Code does not call for water resistant linings in wet areas but it is desirable to specify lining materials which will maintain their integrity longer when exposed more frequently to moisture, and to one-off events such as leaks or flooding.

GIB Aqualine®, GIB Toughline® Aqua and GIB Weatherline® feature a water-resistant polymer impregnated core, designed for wet area applications. These core formulations not only resist penetration of moisture through the lining into the framing behind, but also resist water “wicking” up the core, a common cause of long-term damage where a water-resistant lining has not been used.

WATER ABSORPTION TEST

The illustrations below show how GIB Aqualine®, GIB Toughline® Aqua and GIB Weatherline® compare with standard plasterboard after soaking for two-hours in green dye.

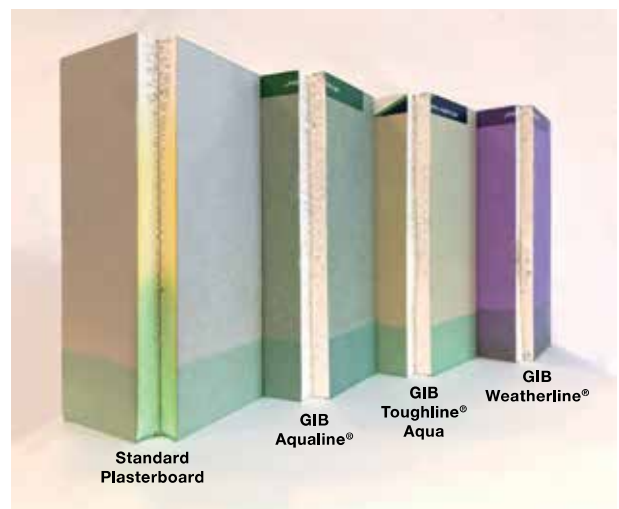

WHERE TO USE GIB® WET AREA LININGS

In order to prolong the life expectancy of the space it is highly desirable to include wet area linings in situations where there is an increased risk of water or moisture damage. Applications include walls and ceilings in bath and shower rooms, and walls in laundries, toilets and kitchens.

BENEFITS

- Water resistant and durable linings help protect against water damage
- Proven substrate for paint, wallpaper, waterproofing membranes, tiles, sheet vinyl and rigid sheet shower linings
- Suitable for both residential and non-residential applications
- Dimensionally stable and an excellent substrate for ceramic tiles
- Conventional jointing methods
- Easy to cut and form openings
- Contains glass fibres and other additives to increase strength and fire resistance
- May be used in GIB® Bracing, GIB® Fire Rated and GIB Noise Control® Systems (see Compliance with the NZ Building Code, Clauses B1, C3 and G6). Consult the appropriate GIB® literature for installation details

HANDLING AND STORAGE

- GIB® plasterboard must be stored under cover, stacked flat and clear of the floor with sufficient support to avoid sagging
- GIB® plasterboard must be handled as a finishing material

LIMITATIONS

- GIB® wet area linings must not be used for bracing purposes in shower cubicles or above baths. For more information refer to page 9 of this manual
- Do not use GIB® wet area linings where exposed for extended periods to humidity levels above 90% RH, such as in group shower or steam rooms, or where exposed to moisture and chlorine rich environments such as in indoor swimming pools
- GIB® wet area linings used in a bathroom or other high humidity environment must not be directly applied to solid plaster (gypsum or cement), wood-based sheet linings or similar materials, masonry or concrete, without strapping or steel furring channels
- GIB® wet area linings must not be installed over a vapour barrier or a wall acting as a vapour barrier
- Cracked or damaged sheets must never be used
- GIB Aqualine® or GIB Toughline® Aqua must not be used in external applications
- GIB® plasterboard must not be exposed to temperatures in excess of 52°C for prolonged periods. Heat-generating devices may include halogen lighting, cooking elements, radiant heating, solid fuel exhausts and fire surrounds. Consult the appliance manufacturer for installation details

Table 1: GIB® Wet Area linings sheet dimensions and weights

Product	Sheet face colour	Thickness (mm)	Sheet width (mm)	Edge Type	Sheet length (mm)						Max. Weight (kg/m ²)
					2400	2450	2700	3000	3600	4800	
GIB Aqualine®	Green	10	1200	TE/TE	■		■	■	■		8.0
			1200	TE/SE	■					■	
			1350	TE/SE	■				■		
		13	1200	TE/TE	■		■	■		11.0	
GIB Toughline® Aqua	Mauve	13	1200	TE/TE	■		■	■		11.4	
GIB Weatherline®	Purple	10	1200	SE/SE		■	■	■		9.0	
		13	1200	SE/SE			■	■		11.5	

BOARD SUBSTITUTION OPTIONS

Acceptable GIB Aqualine® alternatives	
10mm GIB Aqualine® can be replaced with:	10mm GIB Weatherline® 13mm GIB Toughline® Aqua
13mm GIB Aqualine® can be replaced with:	13mm GIB Weatherline® 13mm GIB Toughline® Aqua

GIB® Wet Area System construction details in this manual refer to the use of GIB Aqualine®, GIB Toughline® Aqua and GIB Weatherline® sheets may also be used in place of GIB Aqualine®.

FLEXIBLE SHEET VINYL – SHOWERS AND OTHER WET AREAS

- GIB Aqualine®, GIB Toughline® Aqua and GIB Weatherline® are suitable substrates for flexible vinyl wall finishes in wet areas of residential, commercial or institutional buildings
- Framing requirements and installation procedures are presented in this literature, except that the lining gap at the floor is no more than 5mm when a pencil cove detail is used
- The installation of galvanised steel reinforcing angles behind internal lining corners is recommended for sheet vinyl applications in showers or shower over bath situations
- The lining must be jointed and stopped to a paint quality finish (Level 4) – trowel marks can telegraph even through a commercial grade 2mm vinyl
- A commercial grade vinyl is recommended in commercial or institutional bathrooms and showers
- In areas directly exposed to liquid water, all joints in flexible sheet vinyl must be heat welded
- Installation of flexible vinyl must be carried out strictly in accordance with the specifications provided by the suppliers/ manufacturers of the vinyl

RIGID SHEET SHOWER LININGS

- The wall surface must be free of dust before installation of the lining
- Avoid lining joints as much as possible and where necessary flush with plaster to achieve a level surface
- Do not pre-seal or paint areas which are to be covered by the rigid shower linings
- The suppliers of thin (usually 2-3mm) and rigid acrylic shower linings commonly recommend direct adhesive fixing to wall linings using solvent-based adhesives
- Care must be taken to ensure that rooms are adequately ventilated
- Water temperature changes will cause movement of the thin acrylic sheet, which in turn will stress the adhesive and wall lining substrate
- Consult the supplier of the shower lining for full installation details
- Suppliers of rigid sheet acrylic shower linings recommend a minimum of 24 hours for the adhesive to cure fully prior to the shower being put into service

WATERPROOF MEMBRANE SYSTEMS AND TILING

- A waterproof membrane system must be applied to lining materials used as a substrate for ceramic tiles in a shower or shower over bath situation
- The wall surface in a shower or shower over bath situation is not complete and ready for tiling until coated with a waterproof membrane system over the lining and once penetrations for shower mixers, taps and associated fittings are sealed
- The installation of galvanised steel reinforcing angles behind internal lining corners is required for tiled wall applications in showers or shower over bath situations
- In-situ waterproofing membrane materials manufactured to AS/NZS 4858:2004 “Wet Area Membranes” are recommended and must be applied to manufacturer’s recommendations. Typically, these types of membrane systems are not suitable for paint and wallpaper finishes
- Waterproof membrane systems must be fully cured and dry prior to application of tiling adhesives
- Preformed sheet membranes are also available and may be more suitable where curing times or specialist skills are an issue
- The details shown in this manual are generic in nature. For accurate detailing, follow the specifications provided by the supplier of the proprietary waterproof membrane system

For further information on tiling consult the BRANZ Good Practice Guide – Tiling.

PENETRATIONS AND SEALANTS

As leaks and water ingress typically occur at junctions between building elements and at penetrations, it is essential that particular attention is given to these details at the time of installation. Lack of attention to detail can result in water damage that could remain undetected for a long time.

- Ensure that all cut-outs for pipe penetrations are made neatly, and slightly oversize, with a hole saw. These penetrations should be of a diameter no more than 12mm greater than that of the pipe
- Ensure shower mixer and tap penetrations are sealed with a proprietary flange system to prevent the passage of moisture into the wall cavity
- Sealants should be of a mould inhibiting type and be paintable. Neutral cure silicones will generally meet these requirements
- Surfaces should be dry and free from dust before application, a minimum of a 4mm joint width provided and the depth should not exceed the width
- Apply a bead of sealant to the full depth of the lining in the following locations:
 - Around all tap/pipe bodies
 - The gap between the bath rim and the bottom edge of the wet area lining
 - Between the upstand of preformed shower bases and the bottom edge of the lining
 - Where an impervious junction is required at the floor/wall line, carefully seal the gap between the bottom edge of the board and the finished floor. Leave a 5-10mm gap at the bottom of the wall lining for this purpose, ensuring the gap is free from dirt and dust
- Do not locate shower heads or taps on fire rated or intertenancy walls. Should this be unavoidable always use tested and approved proprietary penetration seals

RENOVATIONS

Bathrooms, kitchens and laundries are the most renovated rooms in the house, partly due to fashion considerations and partly because of damage sustained by ingress of water and moisture.

When renovating these rooms it is often easier and more cost-effective to remove the existing linings and replace them. This allows for a new start in the room and offers sound substrates for new surfaces such as tiling and painting, where otherwise flaking paint or damaged plasterboard may compromise good and sound finish or practice. At the very least re-lining will:

- Allow for inspection of framing where damage may have occurred and provide the opportunity to repair such damage
- Allow plumbing and electrics to be checked and altered or replaced where required
- Provide the opportunity to install thermal and acoustic insulation, water-resistant linings, and propriety plumbing penetration flange systems where appropriate
- Make the job easier

MAINTENANCE

Lack of maintenance is frequently the cause of premature and often expensive failure of components and building elements within wet areas.

It is important to regularly inspect and repair any potential problem before it becomes expensive to reinstate. Good maintenance should include:

- Ongoing ventilation. At the very least, good passive ventilation (e.g. window vents); but good active ventilation (e.g. extraction fans) of an appropriate size for the room is recommended
- Impervious coatings and surfaces should be checked for wear and damage and maintained and re-coated before ingress of water to the substrate occurs
- Regular cleaning with appropriate cleaners so that build-up of matter, such as mould, is well controlled
- Sealants at junctions and penetrations should be checked for adhesion on a regular basis and replaced where adhesion failure to substrates occurs
- Where pipe leaks have become evident, however small, they should be repaired promptly and any area around such leaks dried out completely before any other repairs are carried out

Compliance with the NZ Building Code

STRUCTURE – CLAUSE B1

The design and material specification for steel and timber framing used in GIB® Wet Area systems must be in accordance with the performance requirements of NZ Building Code Clause B1 (Structure).

Bracing elements are required to have a durability of 50 years. GIB® bracing elements are not to be located in shower cubicles or behind baths because of durability requirements, the likelihood of renovation, and practical issues associated with fixing bracing elements to perimeter framing members, such as at bath and shower tray locations.

Otherwise, GIB® Bracing Systems can be used in water-splash areas, provided these are maintained impervious for the life of the building.

GIB Aqualine®, GIB Toughline® Aqua and GIB Weatherline® can be used in place of GIB® Standard plasterboard in GIB® bracing elements. They can also be used in place of GIB Braceline® in GIB® bracing elements 900mm or longer, provided the perimeter of the element is fixed with GIB® Grabber 32mm x 6g screws at 100mm centres, using the GIB Braceline® corner fixing pattern. Refer to the GIB® Bracing System literature.

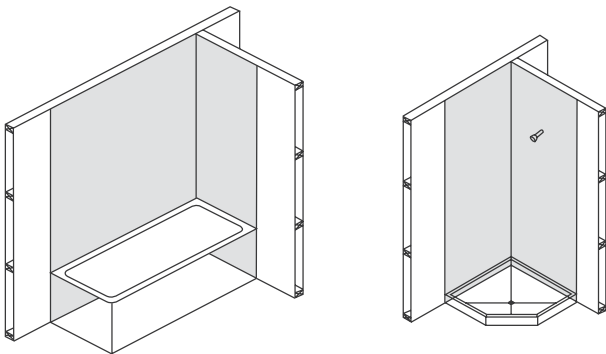

No bracing in the shaded areas.

DURABILITY – CLAUSE B2

When installed and maintained in accordance with this literature, GIB® Wet Area systems tiled or vinyl covered have a serviceable life of at least 15 years. They comply with the requirements of NZ Building Code Clause B2 (Durability) for use in wet areas directly exposed to liquid water, e.g. showers, showers over baths and splash-backs.

When used as a general wet area lining and maintained under normal dry internal conditions, GIB® Wet Area Systems have a serviceable life of at least 50 years and comply with NZ Building Code Clause B2 (Durability) for use within toilets, kitchens, bathrooms and laundries not directly exposed to liquid water.

FIRE AFFECTING AREAS BEYOND THE SOURCE – CLAUSE C3

GIB® Fire Rated Systems provide passive fire protection in accordance with the requirements of NZ Building Code Clause C3. When GIB Aqualine® or GIB Toughline® Aqua is substituted into fire rated systems in place of the equivalent thickness GIB Fyrelite®, the Fire Resistance Rating (FRR) of that system will be maintained.

The protection of combustible surfaces surrounding gas cooking appliances is covered by the latest version of AS/NZS 5601.1.

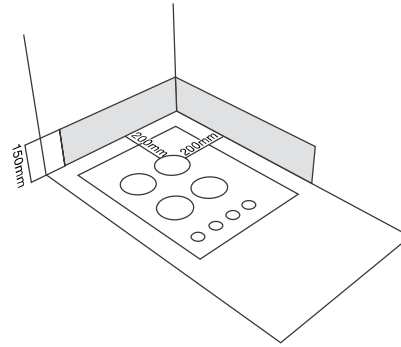

As a guide the following options are acceptable for wall surfaces within 200mm of the periphery of a gas element to a height of 150mm above the element for the full dimension (width and depth) of the cooktop surface area:

- 5mm tiles on GIB® plasterboard
- 5mm toughened glass on GIB® plasterboard
- or any system that can be demonstrated to meet the specific requirements of AS/NZS 5601.1

GIB® plasterboard products must not be exposed to temperatures in excess of 52°C for sustained periods. Check with the appliance manufacturer that this requirement will be met. It would be unusual for surfaces outside 200mm to exceed 52°C for sustained periods.

INTERNAL MOISTURE – CLAUSE E3

The New Zealand Building Code Clauses that relate to wall surfaces are;

E3.3.4 - Wall surfaces adjacent to sanitary fixtures or sanitary appliances must be impervious and easily cleaned.

E3.3.5 - Surfaces of the building elements likely to be splashed or become contaminated in the course of the intended use of the building, must be impervious and easily cleaned.

E3.3.6 - Surfaces of building elements likely to be splashed must be constructed in a way that prevents water splash from penetrating behind linings or into concealed spaces.

New Zealand Building Code Acceptable Solution E3/AS2 substantially refers to the Waterproof Membrane Association Incorporated (WMAI) Code of Practice for Internal Wet Area Membrane Systems (IWAM), August 2020.

The IWAM Code of Practice refers to wet area membranes and over-surfaces that are easy to clean and suggests an extent as outlined below for a typical bathroom application. For further details refer to the IWAM Code of Practice which also lists suitable rigid sheet materials and tiling membranes.

Shaded areas in the diagrams below represent the minimum extent of wall surfaces requiring impervious sheet materials or waterproof membrane systems prior to tiling.

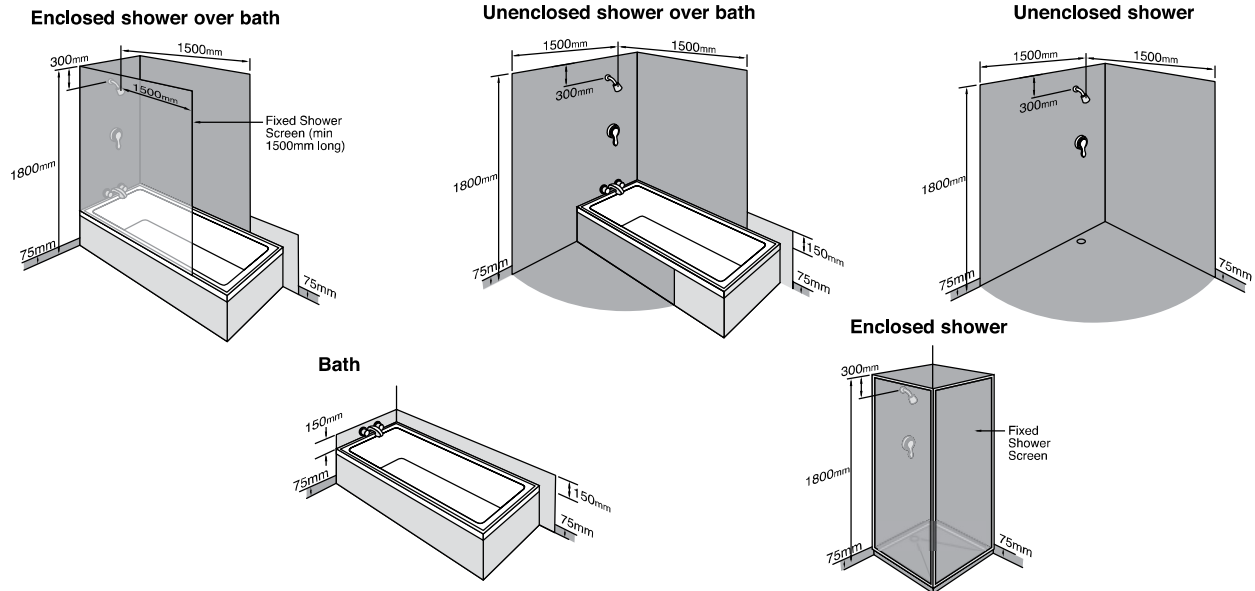

HAZARDOUS BUILDING MATERIALS – CLAUSE F2

At no stage during its serviceable life does GIB Aqualine® constitute a health hazard. It therefore meets the provisions of NZ Building Code Clause F2 (Hazardous Building Materials). Dust resulting from the sanding of stopping compounds may be a respiratory irritant and the use of a suitable facemask is recommended.

VENTILATION – CLAUSE G4

NZ Building Code Clause G4 (Ventilation) requires buildings to have a means of collecting or otherwise removing steam generated from laundering, utensil washing, bathing or showering. To prolong the life of interior linings and surface finishes and to minimise the risk of moisture related problems such as condensation and mould growth, adequate heating, thermal insulation and mechanical ventilation must be provided in kitchens, bathrooms and laundries.

AIRBORNE AND IMPACT SOUND – CLAUSE G6

GIB® Noise Control Systems can be used to provide ratings for Sound Transmission Class (STC) and Impact Insulation Class (IIC) in accordance with the requirements of NZ Building Code Clause G6 (Airborne and Impact Sound). When GIB Aqualine®, GIB Toughline® Aqua or GIB Weatherline® is substituted into GIB® Noise Control systems in place of the equivalent thickness GIB® Standard plasterboard or GIB Fyrelite®, the STC and IIC rating of that system will be maintained. When GIB Aqualine®, GIB Toughline® Aqua or GIB Weatherline® is substituted in place of the equivalent thickness GIB Noiseline®, a small performance loss may occur. For further information refer to the GIB Noise Control® Systems literature or contact the GIB® Helpline 0800 100 442.

TIMBER WALL FRAMING

Framing dimensions must comply with the requirements of NZS 3604:2011.

- The moisture content of timber framing shall be 18% or less at the time of lining
- Studs shall be spaced at 600mm centres maximum for both 10mm and 13mm GIB® plasterboard
- Nogs to be evenly spaced with a maximum spacing of 1350mm. Alternatively, nogs may be staggered 150mm maximum either side of a horizontal joint line
- Nogs are not required behind horizontal joints except in shower situations or specific fire or noise control systems

FASTENERS

- Minimum 32mm x 6g GIB® Grabber® High Thread screws.

FASTENER CENTRES

- 300mm centres to top and bottom plates and to perimeter studs
- Single fasteners to each stud where the horizontal joint crosses the studs

- Place fasteners 12mm from sheet edges and 18mm from sheet ends
- Daubs of GIBFix® adhesive at 300mm centres to intermediate studs
- Do not place adhesive at sheet edges or under fasteners. Sheet edges at door or window openings can be adhesive fixed unless forming part of the perimeter of a bracing element

For bracing, noise control or fire rating applications including fastener lengths consult the relevant GIB® technical publication.

LINING

- Use minimum 10mm GIB® plasterboard
- Install the sheets leaving a 5-10mm gap at the floor line to allow for movement of the framing members and to allow for cleaning dirt and rubbish before sealing
- Sheets to be touch fitted.

JOINTING

- Jointing shall be carried out in accordance with the instructions in the GIB® Site Guide.

Fastening the Linings – Horizontal Fixing Only

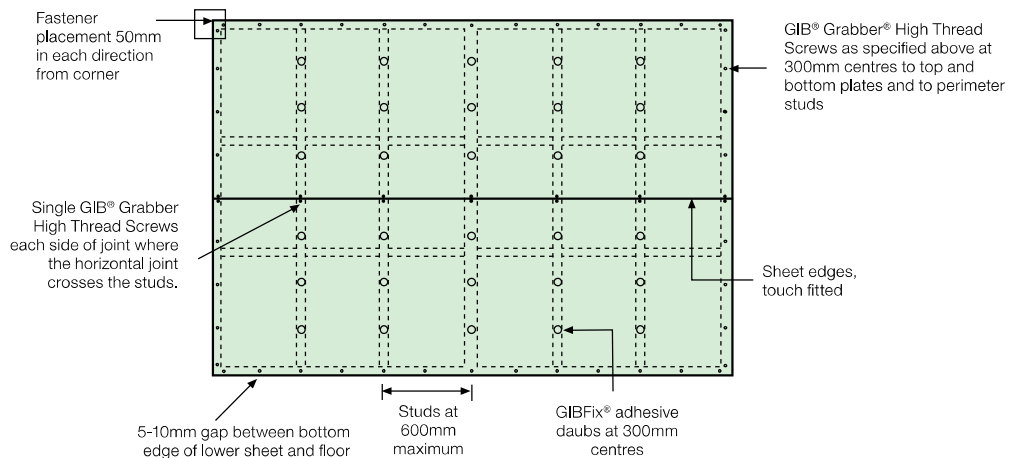

Fastening the Linings – Vertical Fixing Only

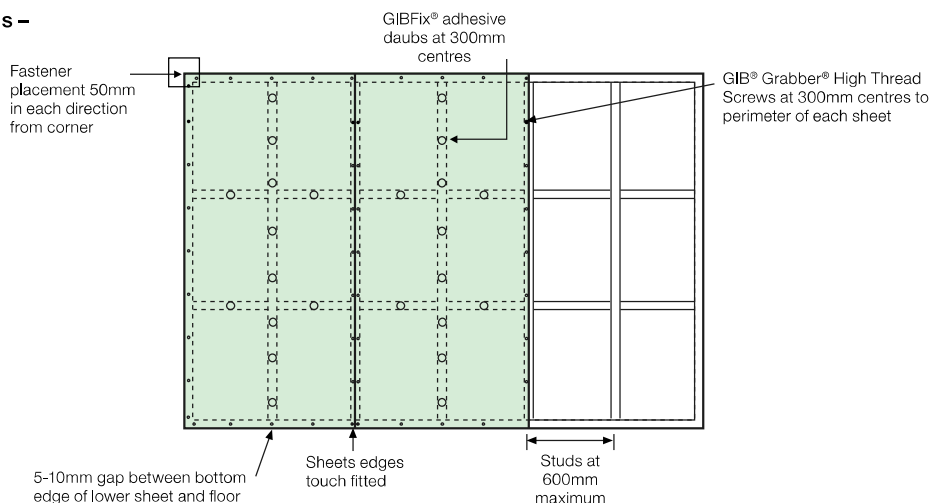

STEEL WALL FRAMING

The minimum sheet thickness for fixing on light gauge 0.55mm base metal thickness (BMT) steel framing is 13mm GIB® plasterboard. For bracing, noise control or fire rating applications consult the relevant GIB® technical publication.

Steel frame for residential construction is in accordance with NZBC B1/AS1 9.1 NASH Standard Part 2 Light Steel Framed Buildings, or by specific design. 10mm GIB plasterboard is commonly used on minimum 0.75mm BMT residential steel framing.

FASTENERS

- Minimum 25mm x 6g GIB® Grabber® Self Tapping Screws.

FASTENER CENTRES

- 300mm centres to top and bottom channels and to end studs
- Single screws to each stud where the horizontal joint crosses the studs
- Place fasteners 12mm from sheet edges and 18mm from sheet ends

- Daubs of GIBFix® All-Bond adhesive or screws at 300mm centres to intermediate studs
- Do not place adhesive at sheet edges or under fasteners.
- Sheet edges at door or window openings can be adhesive fixed.

For bracing, noise control or fire rating applications including fastener lengths consult the relevant GIB® technical publication.

LINING

- Lay the sheets, leaving a 5-10mm gap at the floor line.
Note: If friction fitted steel studs have been used, sheets must be fitted hard to the floor. Ensure floor is cured and dry
- Sheets to be touch fitted.

JOINTING

- Jointing shall be carried out in accordance with the instructions in the GIB® Site Guide

Fastening the Linings – Horizontal Fixing Only

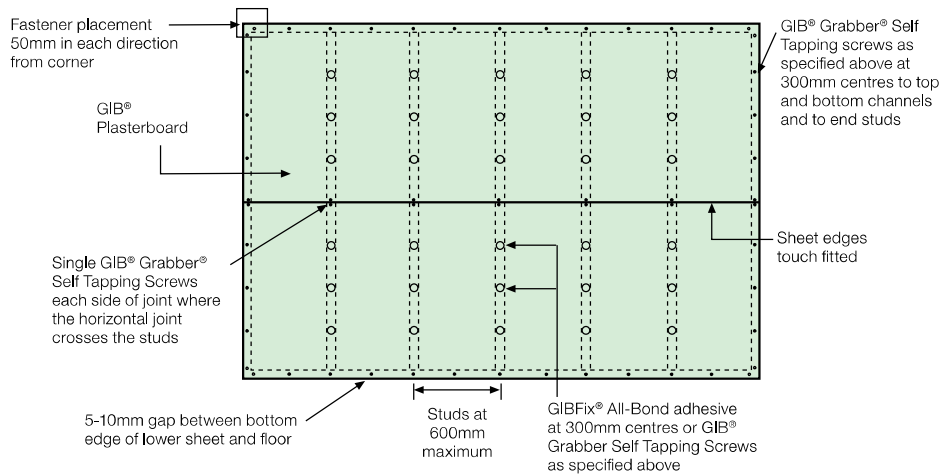

Fastening the Linings – Vertical Fixing Only

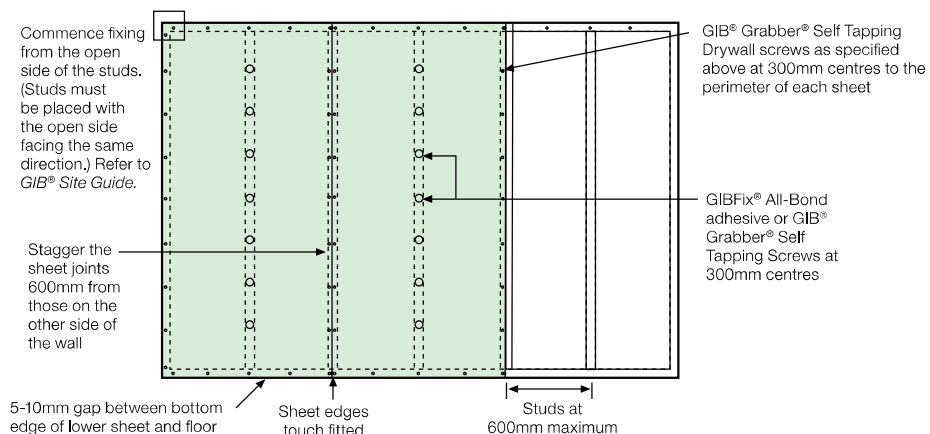

TIMBER WALL FRAMING

Framing dimensions and spacing must be appropriate for the tile weight and comply with the requirements of NZS 3604:2011 Timber Framed Buildings, or relevant specific design Standard.

NOGS

For impact protection in shower cubicles or shower over bath situations it is important that all sheet joints are made on solid framing. This may require vertical fixing or the installation of additional noggs. Also provide noggs:

- Adjacent to each pipe penetration and behind sink and tub flashings
- Between all studs above bath flanges and preformed shower bases

CORNER REINFORCING

- Prior to lining in tiled areas (shower cubicles and shower over bath only) the internal corners shall be reinforced with a minimum
- 32 x 32 x 0.55mm NZ18 or 45 x 45 x 0.55mm GIBFix® Angle. Angles need to be temporarily held in place until secured by the lining fixings.

FASTENERS

- Minimum 32mm x 6g GIB® Grabber® High Thread Screws

FASTENER CENTRES

- 150mm centres to perimeter of wall and all intermediate studs
- Adhesive is not to be used in place of mechanical fasteners
- Place fasteners 12mm from sheet edges and 18mm from sheet ends

- Single fasteners to each stud where the horizontal joint crosses the studs
- Where relevant, fastener lengths must comply with the requirements of GIB® Fire Rated Systems or GIB® Noise Control Systems

For bracing, noise control or fire rating applications including fastener lengths consult the relevant GIB® technical publication.

LINING AND TILE WEIGHTS

- Use minimum 10mm GIB® plasterboard
- For maximum permitted tile weights refer to pg 16 of this manual
- GIB® Wet Area linings may be fixed vertically or horizontally
- Sheets are touch fitted
- Provide a 5-10mm gap at the wall/floor junction and between the bottom edge of the lining and any bath rim or preformed shower base to allow for placement of sealant
- Do not tile on the resilient side of GIB Rail® or STWC Acoustic Clip (ST001) and channel noise control system
- GIB® Wet Area linings are suitable for tiling full height of walls, but if a wall is to be partially tiled (e.g. half high), only the area of wall under the tiles needs to be fixed as required for tiled areas. The remainder of the wall may be fixed as for non-tiled areas

JOINTING

- Jointing shall be carried out in accordance with the instructions of the GIB® Site Guide

Fastening the Linings – Horizontal Fixing Only

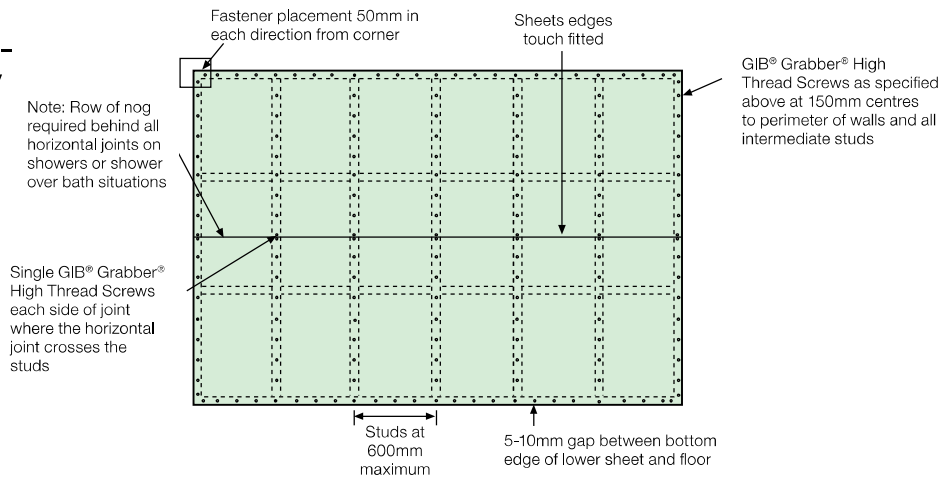

Fastening the Linings – Vertical Fixing Only

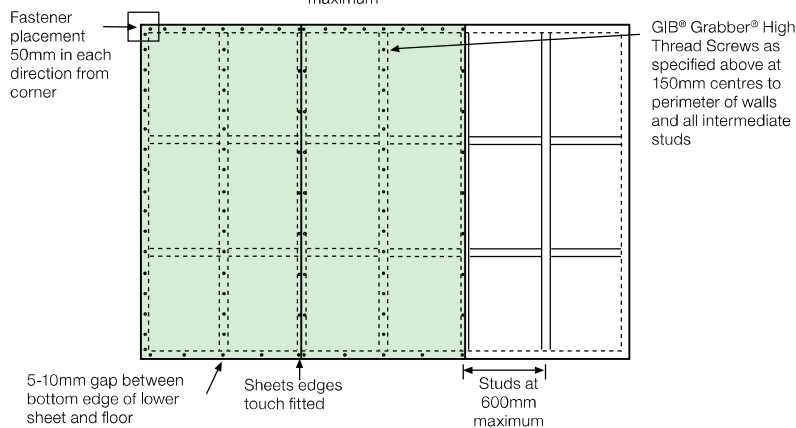

STEEL WALL FRAMING

Framing dimensions and spacing must be appropriate for the tile weight and comply with the requirements of NASH Standard Part 2:2019 Light Steel Framed Buildings, or relevant specific design Standard.

- Linings are placed hard to floor, bedded into a sealant bead
- Steel framing for tiling to have a minimum base metal thickness (BMT) of 0.75mm

NOGS

For impact protection in shower cubicles or shower over bath situations it is important that all sheet joints are made on solid framing. This may require vertical fixing or the installation of additional noggs.

- Adjacent to each pipe penetration and behind sink and tub flashings
- Between all studs above bath flanges and preformed shower bases

CORNER REINFORCING

- Prior to lining in tiled areas (shower cubicles and shower over bath only) the internal corners shall be reinforced with a minimum
- 32 x 32 x 0,55mm NZ18 or 45 x 45 x 0,55mm GIBFix® Angle. Angles need to be temporarily held in place until secured by the lining fixings

FASTENERS

- Minimum 32mm x 6g GIB® Grabber® Self Tapper screws

FASTENER CENTRES

- 150mm centres to perimeter of wall and all intermediate studs
- Adhesive is not to be used in place of mechanical fasteners
- Single screws to each stud where the horizontal joint crosses the studs
- Place fasteners 12mm from sheet edges and 18mm from sheet ends.

For bracing, noise control or fire rating applications including fastener lengths consult the relevant GIB® technical publication.

LINING AND TILE WEIGHTS

- Use minimum 13mm GIB® plasterboard
- For maximum permitted tile weights refer to pg 16 of this manual
- GIB® Wet Area linings may be fixed vertically or horizontally
- Sheets are touch fitted
- Provide a 5-10mm gap at the wall/floor junction and between the bottom edge of the lining and any bath rim or preformed shower base to allow for placement of sealant
- Do not tile on the resilient side of GIB Rail® or STWC Acoustic Clip (ST001) and channel noise control system
- GIB® Wet Area linings are suitable for tiling full height of walls, but if a wall is to be partially tiled (e.g. half high), only the area of wall under the tiles needs to be fixed as required for tiled areas. The remainder of the wall may be fixed as for non-tiled areas

JOINTING

- Jointing shall be carried out in accordance with the instructions of the GIB® Site Guide

Fastening the Linings – Horizontal Fixing Only

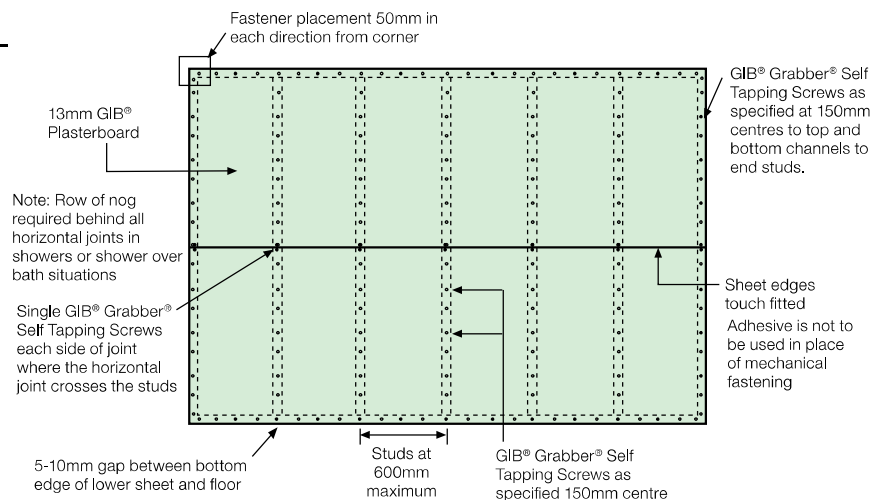

Fastening the Linings – Vertical Fixing Only

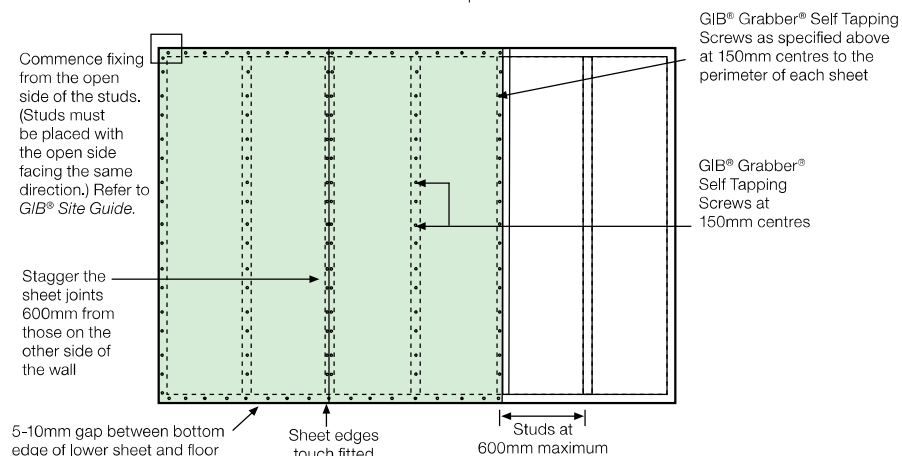

METAL ANGLES FOR TILED INTERNAL CORNERS

- Prior to lining in tiled areas (shower cubicles and shower over bath only) the internal corners shall be reinforced with a minimum 32 x 32 x 0.55mm galvanised metal angle.
- Suitable GIB® metal angle options include:
 - GIB® Rondo® NZ18 metal angle, available length: 3.0m
 - GIBFix® Angle metal angle, available lengths: 2.4m and 2.7m
- Angles need to be temporarily held in place until secured by the lining fixings
- Minimum height of the metal angle is 1800mm

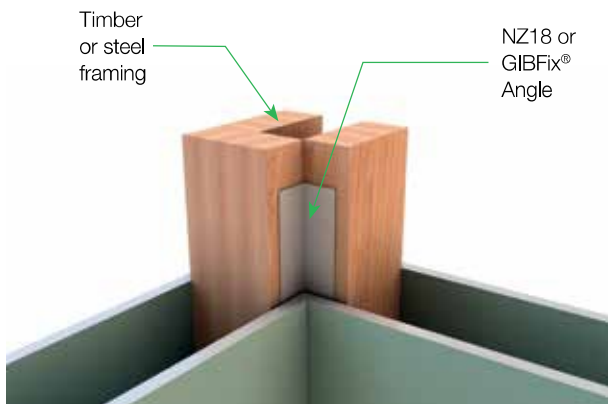
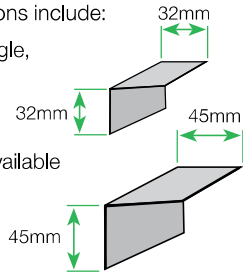
WATERPROOF MEMBRANE SYSTEMS

A waterproof membrane system must be applied to all lining materials used as a substrate for ceramic tiles in a shower or shower over a bath application, or any other tiled application exposed to frequent water splash.

For further information see p10.

TILES AND TILE WEIGHTS

In areas likely to be directly exposed to water, tiles may be ceramic, porcelain or stone must comply with the over-surface finish requirements of the IWAM Code of Practice and be bedded with a suitable tile adhesive on the waterproof membrane system. See page 10 for the minimum extent of wall surfaces requiring impervious sheet materials or waterproof membrane systems prior to tiling.

Smaller mosaic tiles are often lighter, but the integrity of grout joints might be more prone to impact, whilst heavier tiles are larger and have less and deeper grout and sealant joints. For more information also see AS 3958:2007 Ceramic tiles – Guide to the installation of ceramic tiles.

Table 2: Recommended maximum tile weights

Maximum Tile Weights for GIB Aqualine®, GIB Toughline® Aqua or GIB Weatherline®			
Stud Centre (maximum)	Fasteners Centre (maximum)	Lining Thickness	Tile Weight
600mm maximum	150mm maximum	10mm	26kg/m ²
		13mm	40kg/m ²

ADHESIVE AND GROUT WEIGHTS

The weight of adhesive and grout can vary depending on the type of tile and the installation process used. The maximum tile weights stated in table 2 are conservative and refer to the tile weight excluding grout and adhesive used. An additional 3kg/m² has been factored into tile adhesion testing on top of the above stated tile weights to account for adhesive and grout weight used during the installation of the tile.

CEILING FRAMING

Framing dimensions and spacing must comply with the requirements of NZS 3604:2011, NASH for steel or relevant NZ Standard.

For noise control or fire rating applications consult the relevant GIB® technical publication.

FASTENERS

- Steel battens – 25mm x 6g GIB® Grabber® Self Tapping screws
- Timber battens or Joists – 32mm x 6g GIB® Grabber® High Thread screws

ADHESIVES

- Steel battens - GIBFix® All-Bond
- Timber battens - GIBFix® All-Bond or GIBFix® One

FASTENERS CENTRES

- Single screws to the edges and centre of the sheets across each batten
- Single screw at 600mm maximum to the perimeter of the ceiling
- Screws to be 12mm from sheet edges
- Daubs of adhesive at 200mm centres between the screws
- Do not place adhesive at sheet edges or under fasteners, this may lead to screw pops

LINING

- The lining shall be fixed at right angles to the battens or joists
- Commence fixing from the centre of the sheets outwards.
- Sheets to be touch fitted
- Use long length sheets to minimise sheet end butt joints.
- Back-block sheet end butt joints
- See GIB® Site Guide for sheet edge backblocking requirements

BATTEN SPACINGS

- 13mm GIB® plasterboard – 600mm centres maximum
- 10mm GIB® plasterboard – 450mm centres maximum

JOINTING

- All sheet joints must be paper tape reinforced and stopped in accordance with instructions in the GIB® Site Guide
- Do not fix tiles to GIB® plasterboard ceilings

Maximum GIB® Rondo® metal ceiling batten centres:

- 600mm for 13mm GIB® plasterboard
- 450mm for 10mm GIB® plasterboard

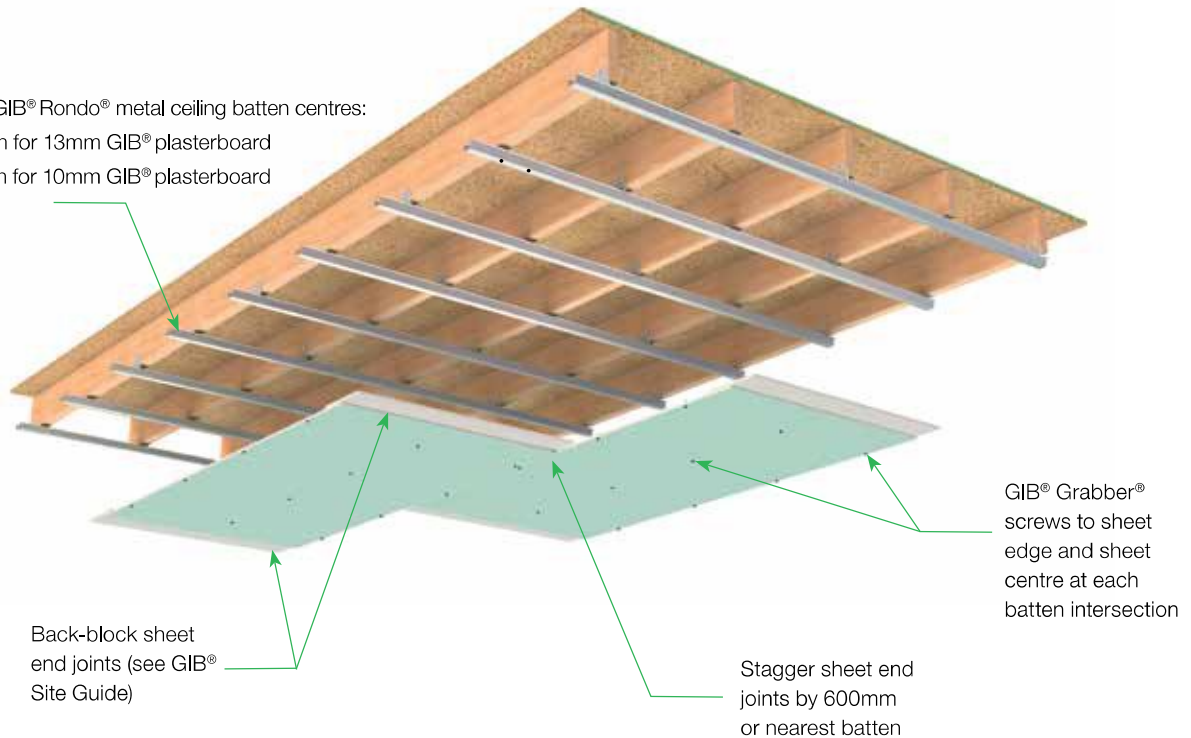

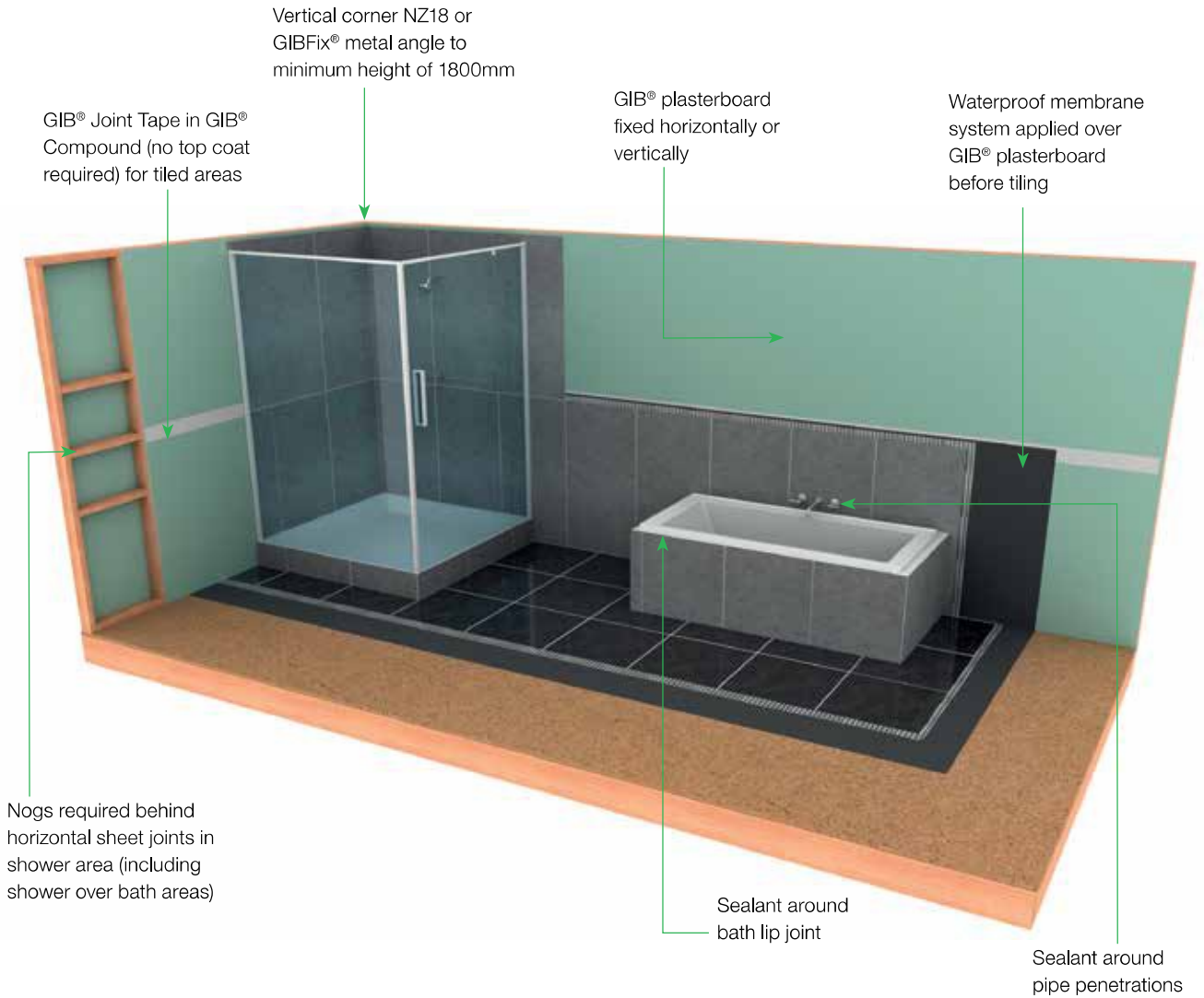

A: TILED INTERNAL CORNER

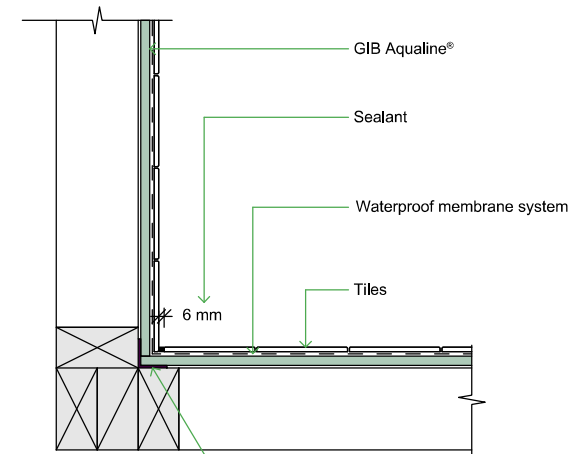

GAL-029

32 x 32 x 0.55mm vertical fixed galvanised steel angle NZ18 or GIBFix® Angle

B: CERAMIC FLOOR LINING JUNCTION

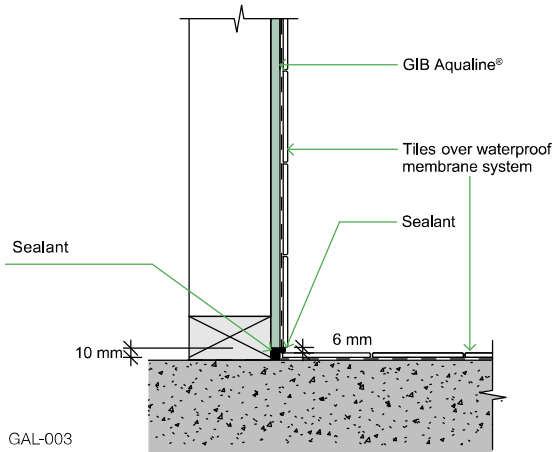

GAL-003

C: BATH LINING JUNCTION

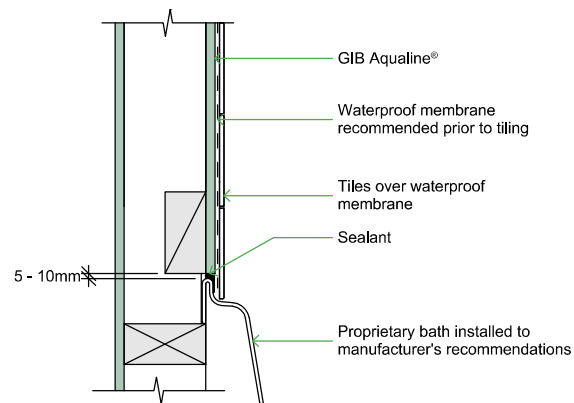

GAL-006

G: SHOWER MIXER PENETRATION IN WET WALL LININGS

Refer to the shower mixer manufacturer for shower mixer installation detailing including the use of proprietary products to prevent water or moisture ingress behind the wet wall lining.

D: SEALING WET AREA PENETRATION

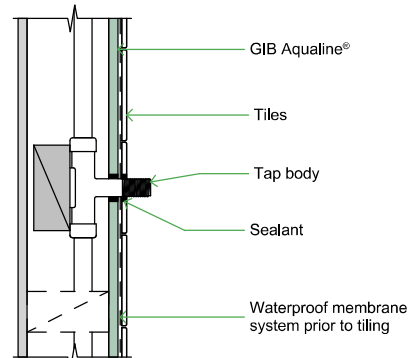

GAL-002

E: BATH CRADLE LINING DETAIL

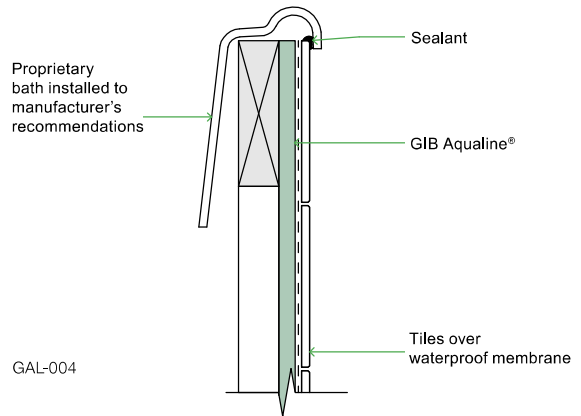

GAL-004

F: VANITY TOP LINING JUNCTION

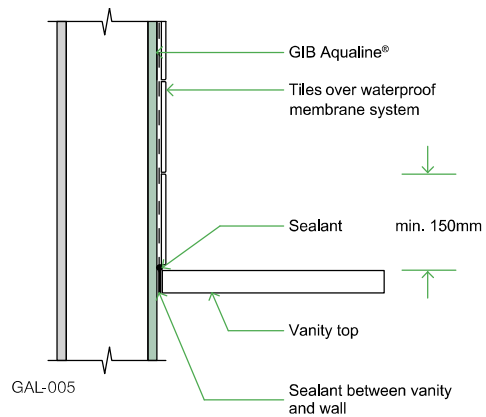

GAL-005



A: BATH LINING JUNCTION

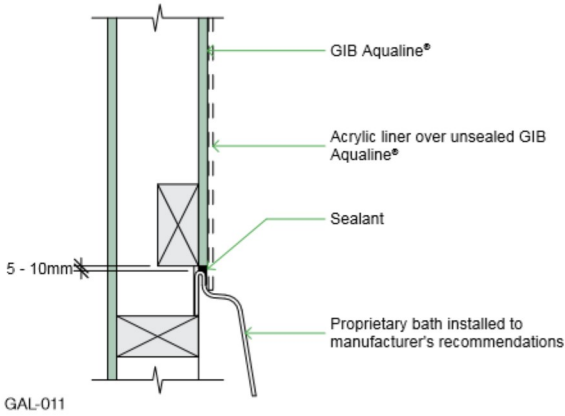

D: CERAMIC FLOOR SKIRTING LINING JUNCTION

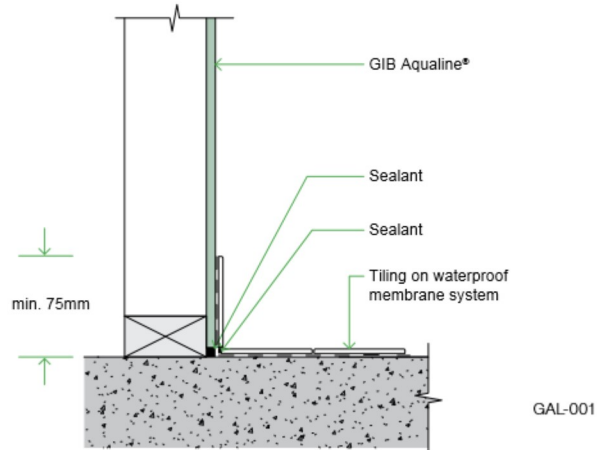

B: VANITY TOP LINING JUNCTION

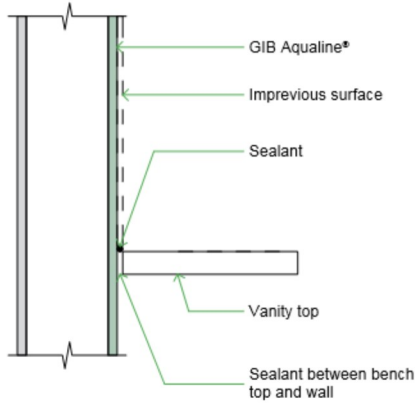

E: SEALING SEMI WET AREA PENETRATION

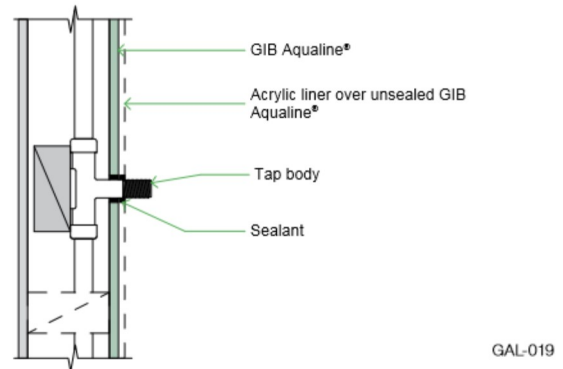

C: UNSEALED PLASTERBOARD LINING

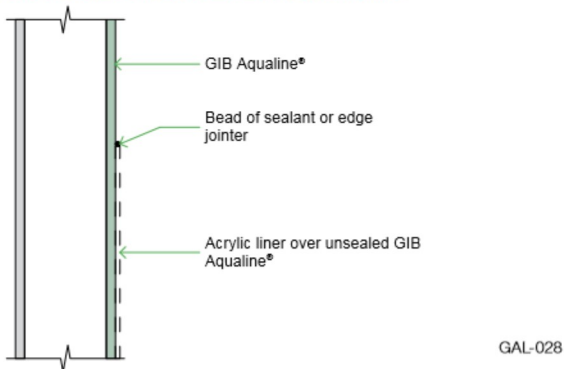

F: SHOWER MIXER PENETRATION IN WET WALL LININGS

Refer to the shower mixer manufacturer for shower mixer installation detailing including the use of proprietary products to prevent water or moisture ingress behind the wet wall lining.



A: BATH LINING JUNCTION

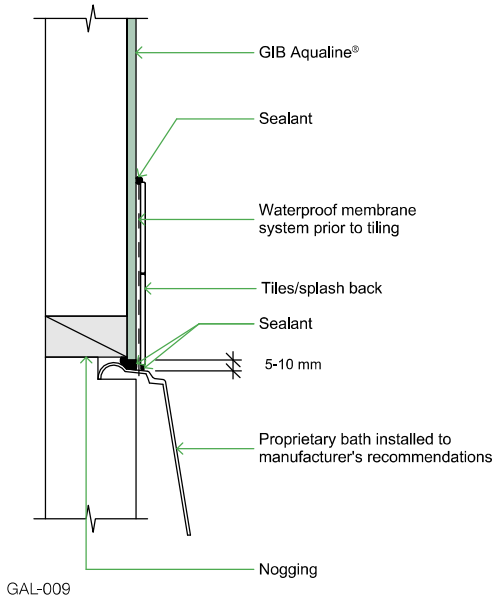

D: BATH LINING JUNCTION

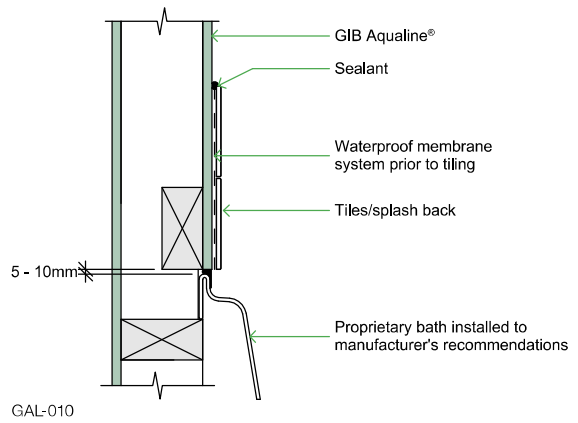

B: SEALING SEMI WET AREA PENETRATION

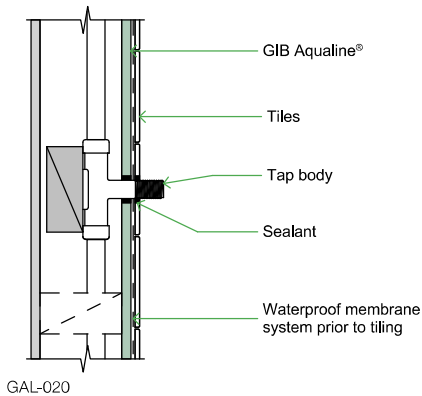

E: CRADLE VINYL LINING JUNCTION

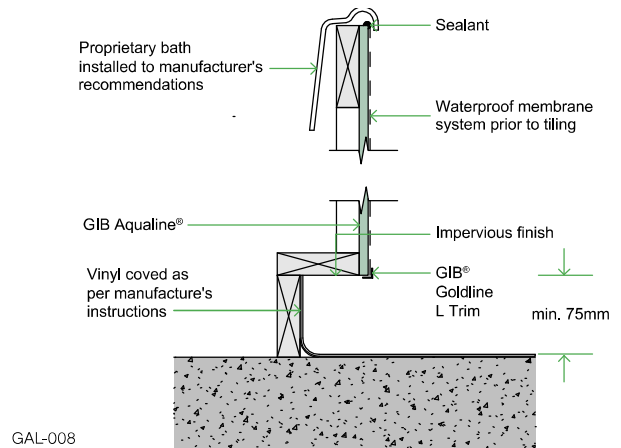

C: VANITY TOP LINING JUNCTION

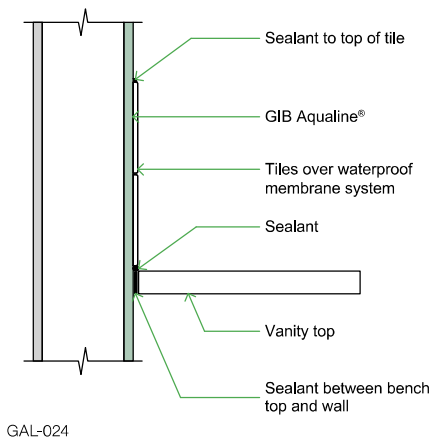

A: MORTAR UNDER CERAMIC FLOOR LINING JUNCTION

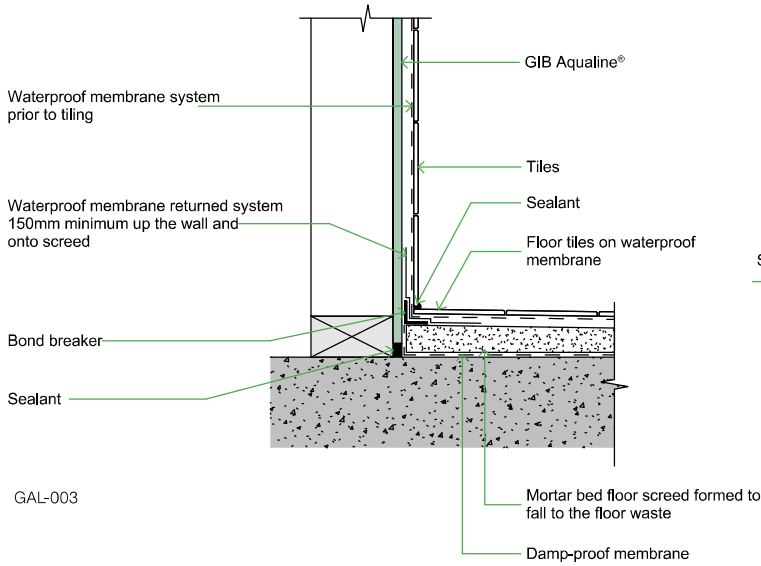

C: CERAMIC FLOOR LINING JUNCTION

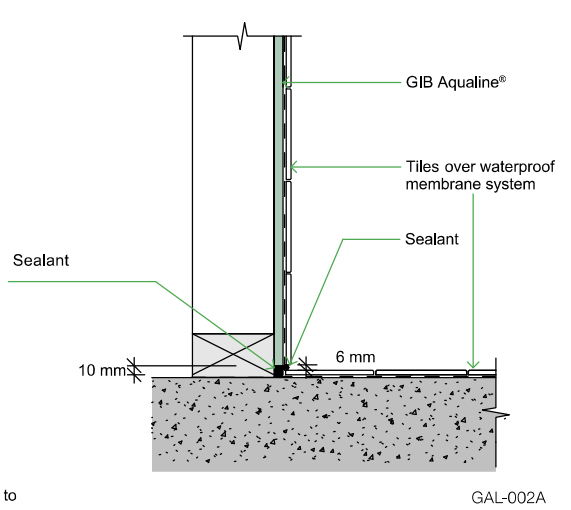

PREFORMED SHOWER BASE JUNCTIONS

Refer to the shower base manufacturer for proprietary shower tray installation detailing including wet wall lining junction detailing.

B: TILED INTERNAL CORNER

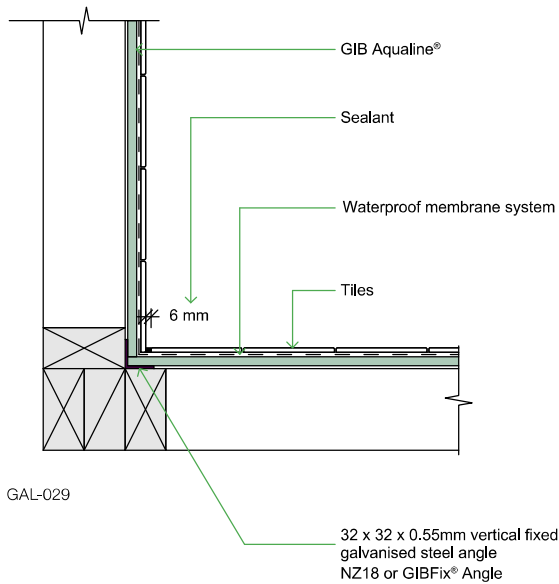

D: TILED INTERNAL CORNER METAL ANGLE POSITION

Refer to page 16 of this publication for specification and installation guidance.

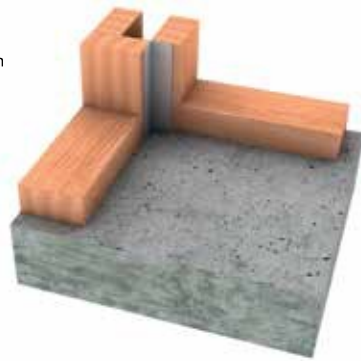

E: SHOWER MIXER PENETRATION IN WET WALL LININGS

Refer to the shower mixer manufacturer for shower mixer installation detailing including the use of proprietary products to prevent water or moisture ingress behind the wet wall lining.



A: CERAMIC FLOOR SKIRTING LINING JUNCTION

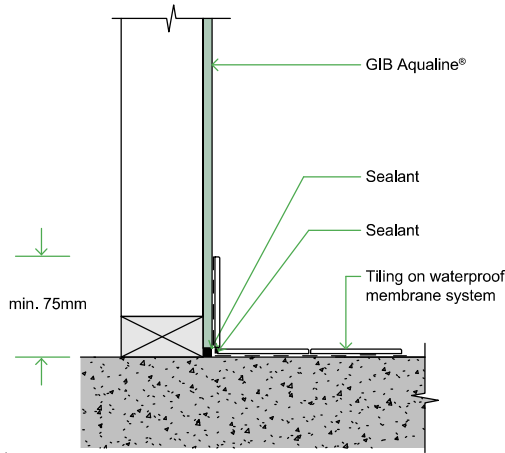

GAL-001

C: TILED INTERNAL CORNER

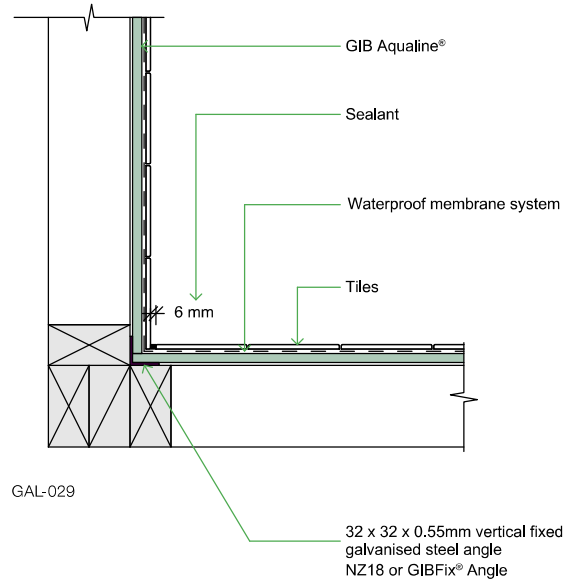

GAL-029

B: MOULDED SHOWER TRAY DOUBLE LINING JUNCTION

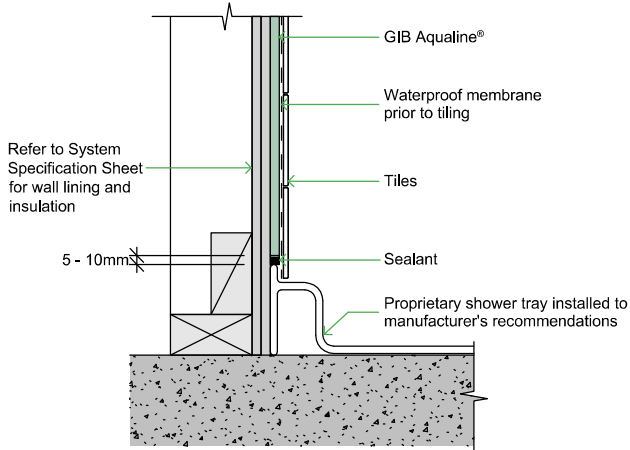

GAL-016

D: TILED INTERNAL CORNER METAL ANGLE POSITION

Refer to page 16 of this publication for specification and installation guidance.

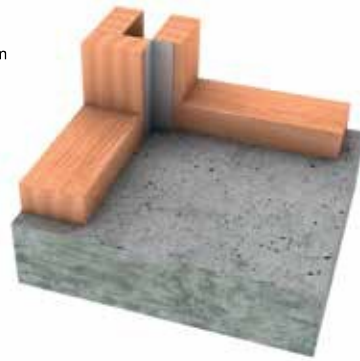

E: SHOWER MIXER PENETRATION IN WET WALL LININGS

Refer to the shower mixer manufacturer for shower mixer installation detailing including the use of proprietary products to prevent water or moisture ingress behind the wet wall lining.



A: MOULDED SHOWER TRAY DOUBLE LINING JUNCTION

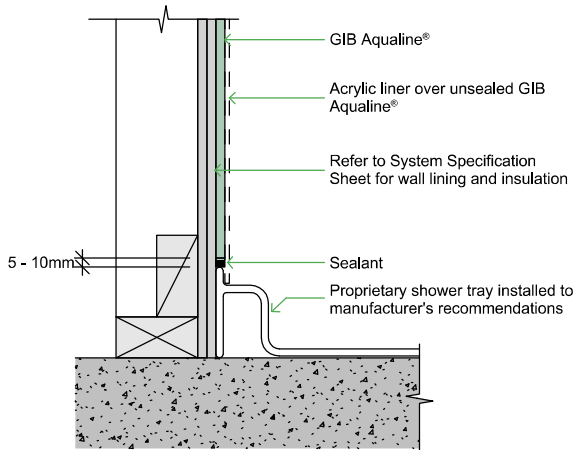

GAL-015

C: UNSEALED PLASTERBOARD LINING

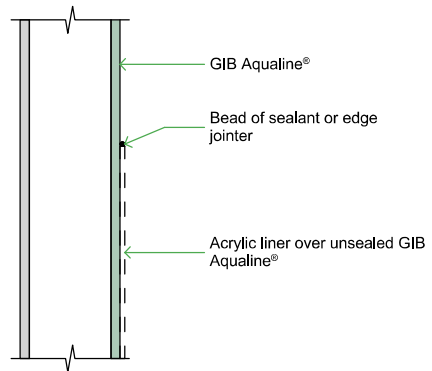

GAL-028

B: CERAMIC FLOOR SKIRTING LINING JUNCTION

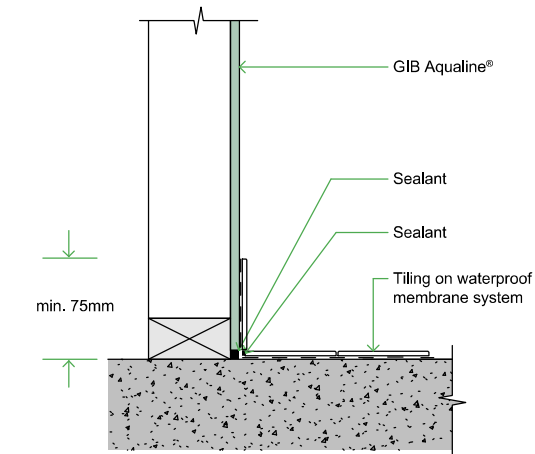

GAL-001

D: SHOWER MIXER PENETRATION IN WET WALL LININGS

Refer to the shower mixer manufacturer for shower mixer installation detailing including the use of proprietary products to prevent water or moisture ingress behind the wet wall lining.



A: BENCH TOP LINING JUNCTION

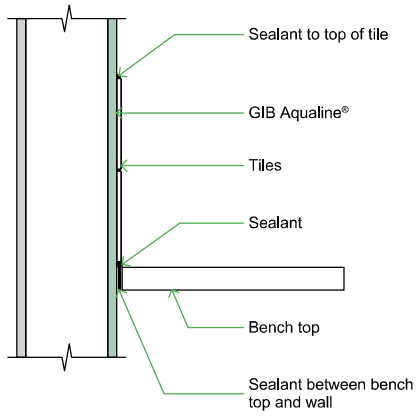

GAL-024

CERAMIC FLOOR SKIRTING LINING JUNCTION

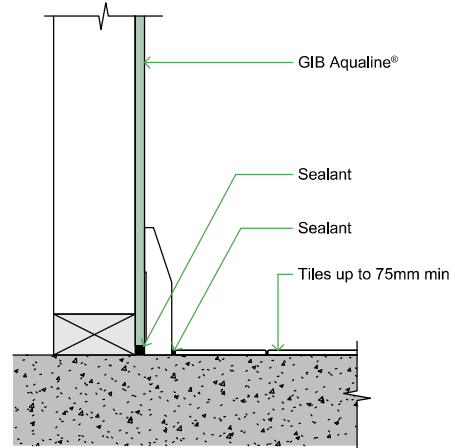

GAL-001A

B: COOKTOP LINING JUNCTION

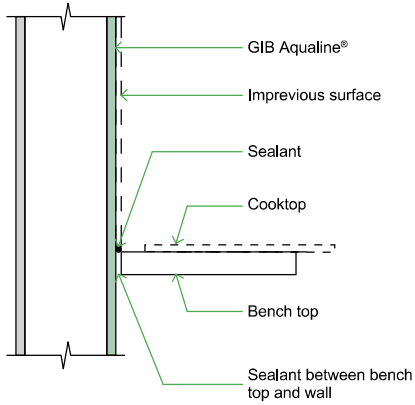

GAL-023B



A: VANITY TOP LINING JUNCTION

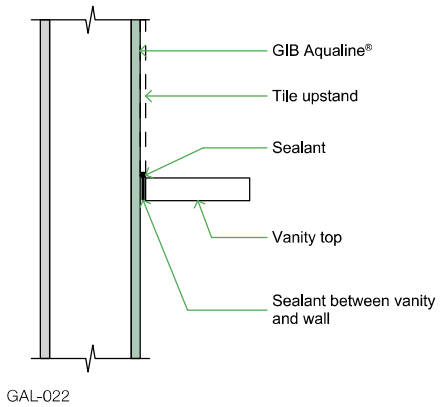

B: SEALING WET AREA PENETRATION LINING JUNCTION

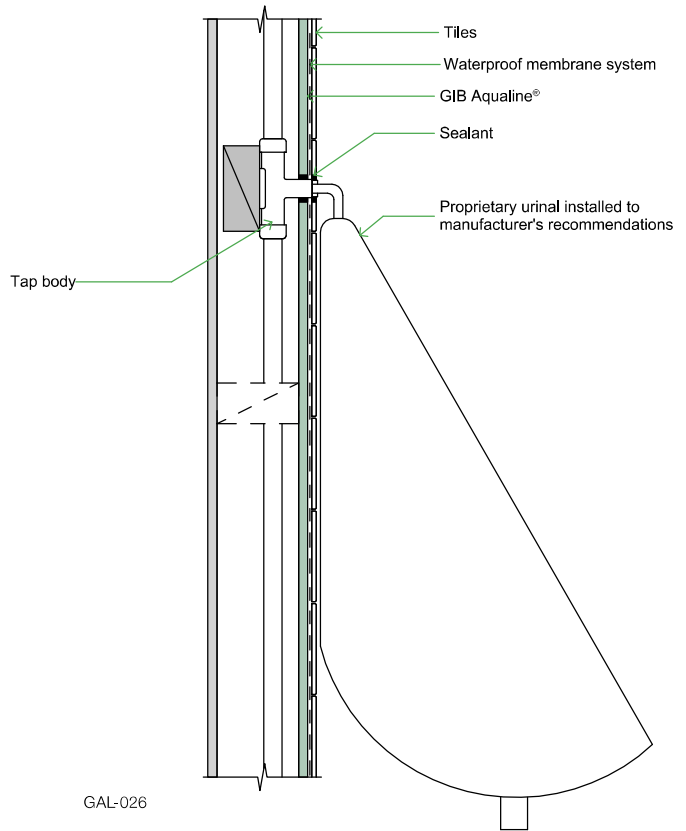

A: SURFACE MOUNTED WITH NOG

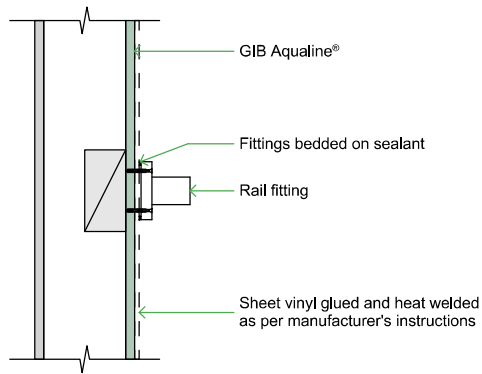

GAL-027

C: BASIN LINING JUNCTION

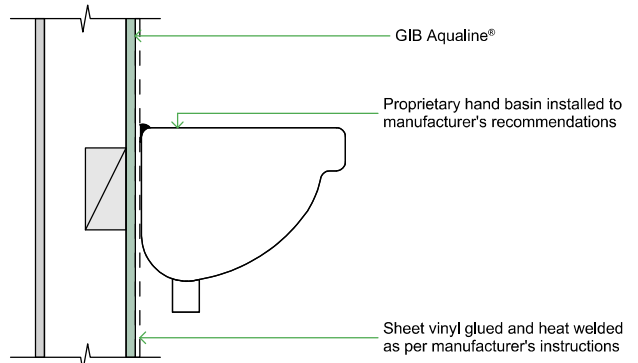

GAL-025

B: VINYL FLOOR LINING JUNCTION

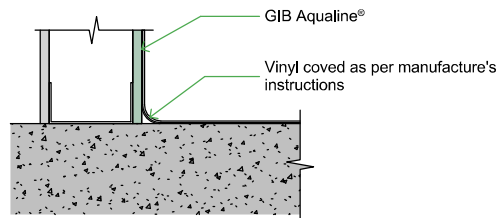

GAL-006A



A: MOULDED SHOWER TRAY DOUBLE LINING JUNCTION

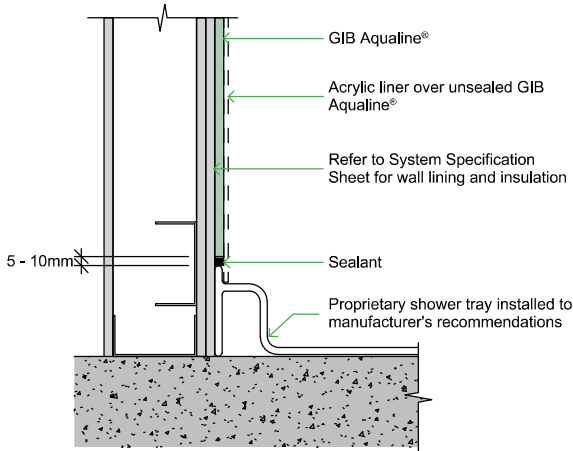

GAL-017

C: MOULDED SHOWER TRAY DOUBLE LINING JUNCTION

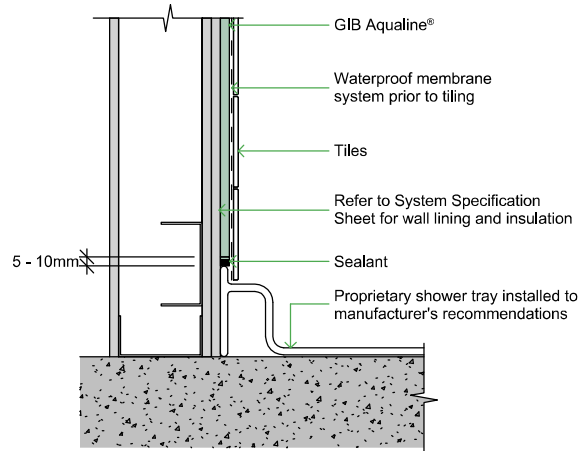

GAL-018

B: BATH DOUBLE LINING JUNCTION

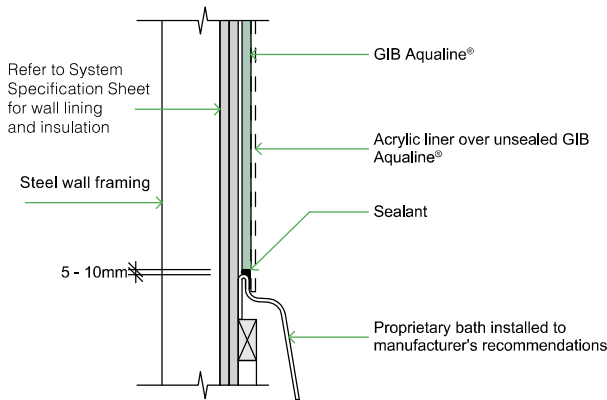

GAL-013

D: BATH DOUBLE LINING JUNCTION

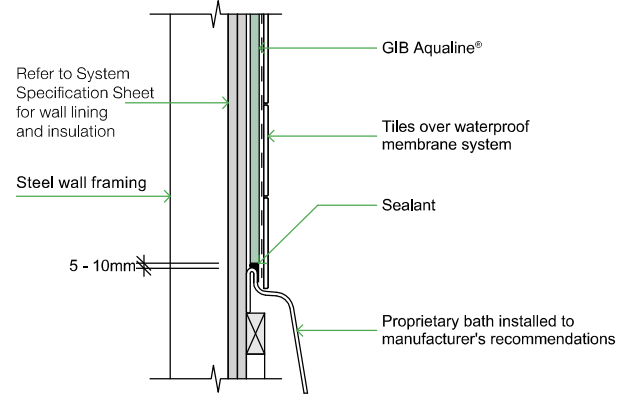

GAL-014

GIB® WET AREA SYSTEMS FIRE RESISTANCE AND NOISE CONTROL PERFORMANCE

Given recesses required for shower trays, bath upstands, etc., and the likelihood of renovations during the service life of the building, it is recommended that GIB® Wet Area linings in water splash areas are installed in addition to and over required fire and noise control systems in commercial or multi-residential applications.

Do not tile on the resilient side of a GIB Rail® or Acoustic Resilient Mount (ST-001) and channel noise control system.

E: INTERTENANCY WALL AND WET AREA WALL JUNCTION

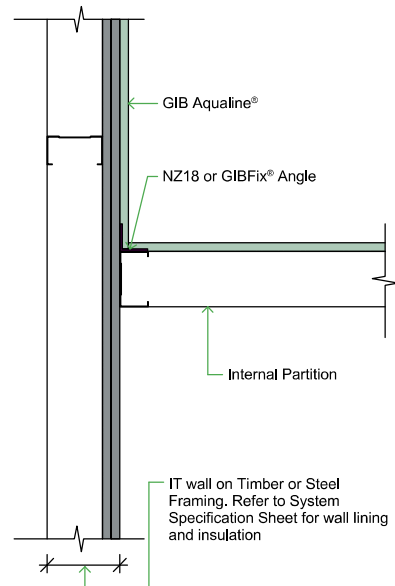

GAL-031C

TIMBER FRAME TILE RECESS

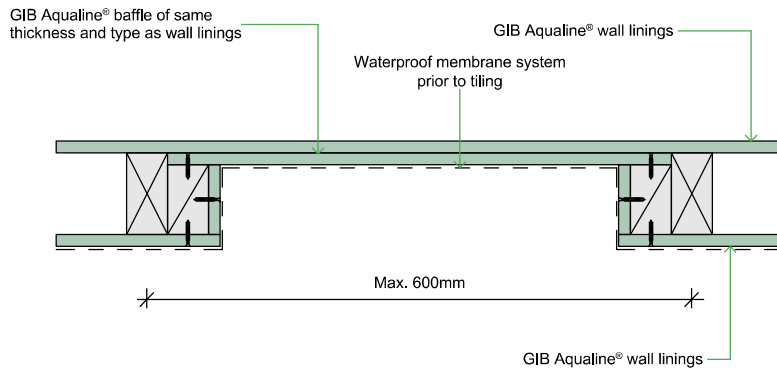

Larger recesses can be accommodated depending on specific framing layout provided 500mm is not exceeded in at least one direction.

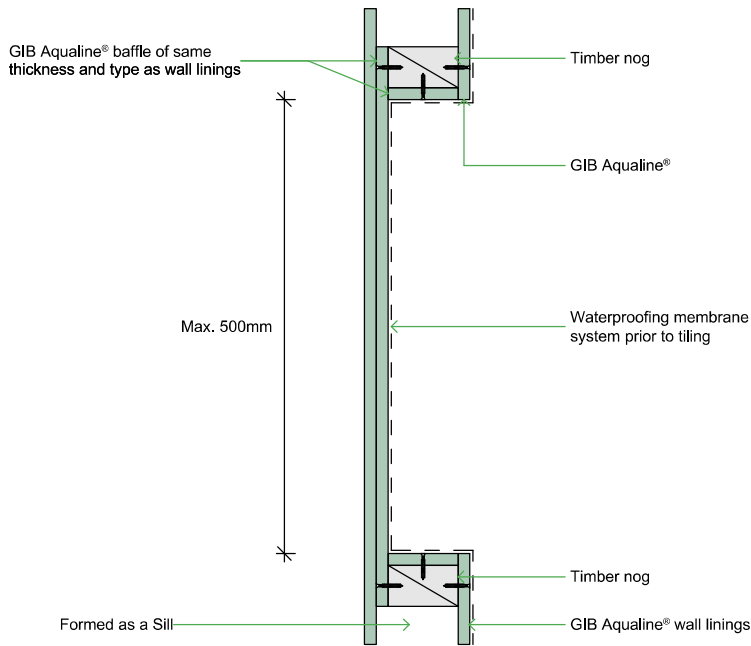

GAL-029B

STEEL FRAME TILE RECESS

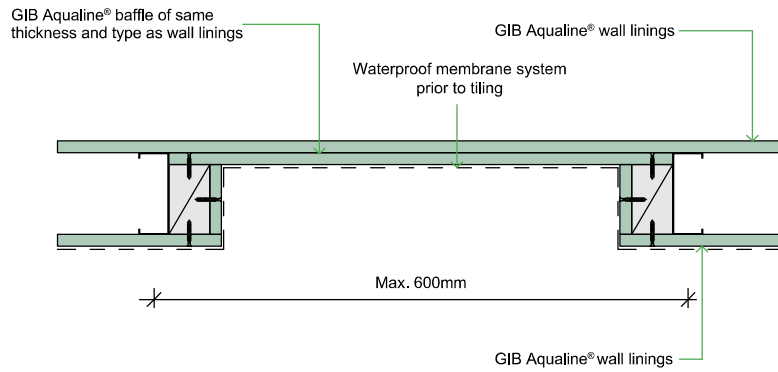

Larger recesses can be accommodated depending on specific framing layout provided 500mm is not exceeded in at least one direction.

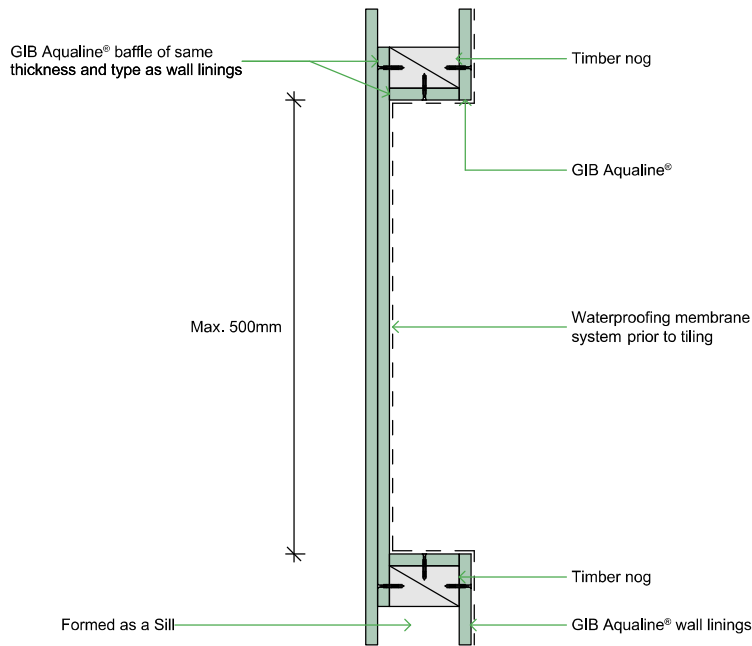

GAL-030

GIB® Wet Area Systems, February 2021

LIMITATIONS

Winstone Wallboards Ltd accepts no liability if the GIB® Wet Area Systems and junction details are not installed in strict accordance with instructions contained within this publication.

USE ONLY THE CURRENT SPECIFICATION

This publication may be superseded by a new publication. Winstone Wallboards accepts no liability for reliance upon publications that have been superseded. You should check the GIB® website to ensure you are using the current publication. If you are unsure whether this is the current publication, simply call the GIB® Helpline on 0800 100 442.

SUBSTITUTION

GIB® Wet Area Systems have been specifically designed and tested to achieve the stated performance levels. To maintain the GIB® Product and System Warranty, all system components detailed in this publication must be used when specifying and installing GIB® Wet Area Systems.

TRADEMARKS

The names GIB®, GIB Fyreline®, GIB Ultraline®, GIB Toughline®, GIB Braceline®, GIB Noiseline®, GIB Aqualine®, GIB Weatherline®, GIB Tradeset®, GIB Plus 4®, GIB-Cove®, GIB Lite Blue®, GIBFix®, GIB® Quiet Stud®, GIB Rail®, GIB Barrierline®, GIB X-Block®, GIB Fire Soundseal®, GIB Clip®, the colour mauve for GIB Toughline®, the colour blue for GIB Braceline®, GIB Noiseline®, the colour pink for GIB Fyreline®, the colour green for GIB Aqualine®, the colour purple for GIB Weatherline® and the shield device are registered trademarks of Fletcher Building Holdings Limited.

COPYRIGHT

All of the material contained in this brochure, including all text, tables, charts, graphs, drawings, images and diagrams, are protected by copyright. These materials may not be reproduced, adapted or transmitted in any form by any process, without the permission of Winstone Wallboards Ltd.

Copyright© Winstone Wallboards Ltd, 2021.



FOR MORE INFORMATION VISIT

gib.co.nz

OR CALL THE GIB® HELPLINE

0800 100 442